

SPICE thermal model

BUK7E1R9-40E

Symbol	Parameter	Conditions	Min	Typ	Max	Unit
$R_{th(j-mb)}$	thermal resistance from junction to mounting base		-	-	0.47	K/W

C_{th1}	2.404E-04 F
C_{th2}	1.735E-03 F
C_{th3}	1.299E-03 F
C_{th4}	4.873E-03 F
C_{th5}	1.648E-02 F
C_{th6}	2.996E-02 F
C_{th7}	6.007E-01 F
C_{th8}	1.529E+02 F
R_{th1}	3.714E-04 Ω
R_{th2}	7.331E-04 Ω
R_{th3}	8.493E-03 Ω
R_{th4}	2.053E-02 Ω
R_{th5}	6.988E-02 Ω
R_{th6}	2.879E-01 Ω
R_{th7}	8.385E-02 Ω
R_{th8}	1.433E-03 Ω

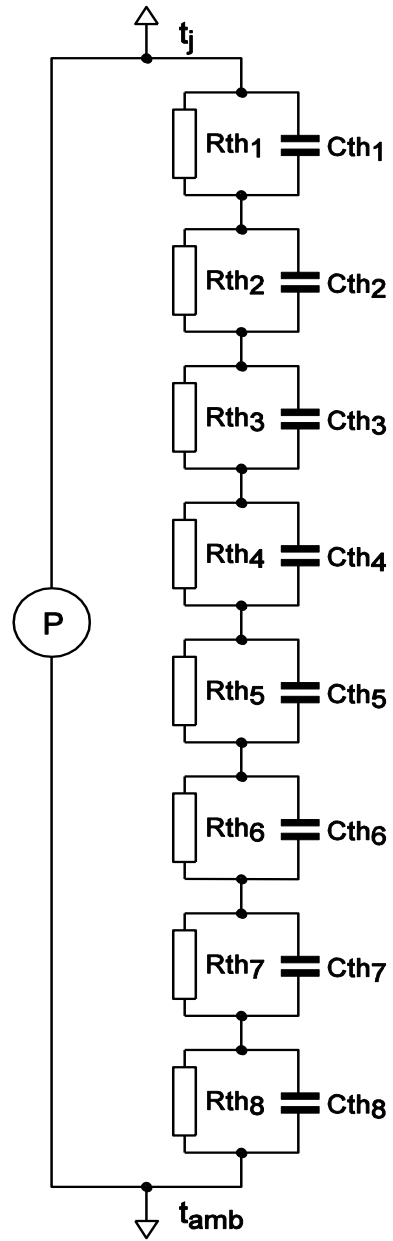

001aal768

Part: BUK7E1R9-40E
 Date: 11/4/2013
 R_{th} 0.47 K/W